

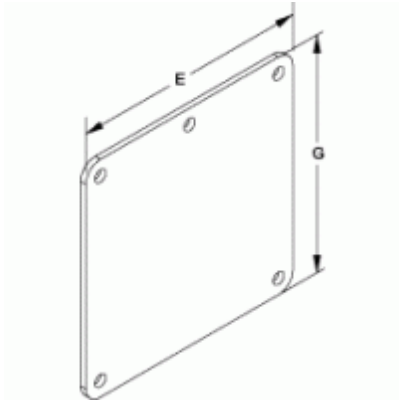

Quality Products. Service Excellence.

Cover Plate 1487H Series



Construction

- Covers are formed from 10 gauge mild steel.
- Solid oil resistant gasket and hardware included with each cover plate.

Finish

- Finished in ANSI 61 gray.

Part No.	For use with	H	W
1487BH	2.5 x 2.5	3.87	3.87
1487CH	4 x 4	5.37	5.37
1487DH	6 x 6	7.62	7.62
1487EH	8 x 8	9.62	9.62

Data subject to change without notice

© 2020. Hammond Manufacturing Ltd. All rights reserved.